

CS-108/P1001 Series

8.4" TFT-LCD Sunlight Readable Touch Panel PC with Intel® Atom™ E3845 Quad Core Processor



POWER EFFICIENT SUNLIGHT READABLE PANEL PC

| CS-100/P1000 Series |

Overview

 CONTACT

CS-100/P1001 Series is a 8.4" - 24" TFT-LCD sunlight readable touch panel PC offering 1,500 nits - 1,800 nits ultra high brightness and 800 x 600 - 1920 x 1080 resolution. The system is equipped with Intel® Atom® E3845 processor and provides extensive I/O including 2x GbE, 4x USB, 2x RS232/422/485, 4x DI/4x DO, 1x VGA and 1x DisplayPort. It also supports 1x Mini-PCIe slot and 1x SIM socket for a variety of wireless connections, such as BT/WiFi and 3G/LTE. In addition, there are 2 types of storage devices including 2.5" SATA HDD and CFast. The accessible design of these storage devices allows quick data access and easy maintenance. CS-100/P1001 Series supports Convertible Display System (CDS) technology. Comparing to regular standalone panel PCs, it can lower maintenance cost and reduce unplanned downtime. Furthermore, CS-100/P1001 Series is a truly rugged display system supporting wide range operating temperature, IP65 dust/water proof front panel, wide range DC power input (9 to 48VDC) and rigorous industrial protections.

Key Features

- 8.4" TFT-LCD with Ultra High Brightness up to 1,600 nits and 800 x 600 (SVGA) Resolution
- Onboard Intel® Atom™ E3845 Processor Quad Core, 1.91GHz
- Supports 1x DDR3L SO-DIMM Socket, up to 8 GB
- 1x 2.5" SATA Drive Bay, 1x CFast Card and 1x SIM Card Socket
- 2x GbE LAN, 4x USB, 2x COM, 1x VGA, 1x DisplayPort, 4x DI/4x DO
- 1x Mini-PCIe Expansion Socket for Wireless and I/O Expansion
- Wide Range Operating Temperature
- Designed with Aluminum Die-casting Front Frame
- True Flat IP65 Front Panel Protection
- Supports Panel / VESA / Rack Mounting
- Convertible Display System (CDS) Technology Supported
- 2x Universal I/O Bracket (For P1001E only)

Certifications



Sunlight Readable

Providing ultra high brightness 1,500 nits - 1,800 nits and resolution up to 800 x 600 - 1920 x 1080 (XGA), CS-100/P1000 Series is suitable for all lighting conditions including direct sunlight.



Wide Temperature

CS-100/P1000 Series supports wide range operating temperature and is suitable for deploying in extreme and harsh environments.

Multiple Functions

CS-100/P1000 Series provides extensive I/O, Mini-PCIe slot, 2.5" SATA drive bay, CFast socket, and SIM card slot.



CS-108 Specifications

Model Name	CS-108
Display	
LCD Size	• 8.4" (4:3)
Max. Resolution	• 800 x 600
Brightness (cd/m2)	• 1600
Contrast Ratio	• 600 : 1
LCD Color	• 16.2M
Pixel Pitch (mm)	• 0.213 (H) x 0.213 (V)
Viewing Angle (H-V)	• 160 / 140
Backlight LED Life Time	• 50,000 hrs (LED Backlight)
Touch Screen	
Touch Type	• Projected Capacitive
Physical	
Dimension (W x D x H)	• 262 x 186.2 x 56.2mm
Weight Information	• 1.58kg
Mechanical Construction	• Flat Rugged Aluminum Die-casting Bezel
Power	
Power Consumption	• 9.48W (Max.)
Environment	
Front Panel Protection	• IP 65 Compliant
Operating Temperature	• -20°C to 70°C (With Industrial Grade Peripherals; Ambient with air flow)
Storage Temperature	• -20°C to 70°C
Relative Humidity	• 85% RH @ 40°C (Non-condensing)
EMC	• CE, UKCA, FCC, ICES-003 Class A
EMI	<ul style="list-style-type: none"> • CISPR 32 Conducted & Radiated: Class A • EN/BS EN 55032 Conducted & Radiated: Class A • EN/BS EN IEC 61000-3-2 Harmonic current emissions: Class A • EN/BS EN61000-3-3 Voltage fluctuations & flicker • FCC 47 CFR Part 15B, ICES-003 Conducted & Radiated: Class A
EMS	<ul style="list-style-type: none"> • EN/IEC 61000-4-2 ESD: Contact: 4 kV; Air: 8 kV • EN/IEC 61000-4-3 RS: 80 MHz to 1000 MHz: 3 V/m • EN/IEC 61000-4-4 EFT: AC Power: 1 kV; DC Power: 0.5 kV; Signal: 0.5 kV • EN/IEC 61000-4-5 Surges: AC Power: 2 kV; Signal: 1 kV • EN/IEC 61000-4-6 CS: 3V • EN/IEC 61000-4-8 PFMF: 50 Hz, 1A/m • EN/IEC 61000-4-11 Voltage Dips & Voltage Interruptions: 0.5 cycles at 50 Hz
Safety	• UL, cUL, CB, IEC, EN 62368-1

P1001 Series Specifications

Model Name	P1001	P1001E
System		
Processor	• Onboard Intel® Atom™ Processor E3845 Quad Core, 1.91 GHz	
Memory	• 1x DDR3L 1066/1333 MHz SO-DIMM Socket (un-buffered and non-ECC) • Support up to 8 GB	
BIOS	• AMI 64Mbit SPI BIOS	
Graphics		
CDS (Convertible Display System) Technology	• 1x Convertible Display System (CDS) Interface	
VGA	• 1x VGA Connector (1920x1080@60Hz)	
DP	• 1x DisplayPort Connector (1920x1080@60Hz)	
Audio		
Line-out	• 1x Line-out, Phone Jack 3.5mm	
Mic-in	• 1x Mic-in, Phone Jack 3.5mm	
I/O		
LAN	• 2x GbE LAN (Supports WoL, Teaming, Jumbo Frame & PXE), RJ45 - GbE1: Intel® I210 - GbE2: Intel® I210	
USB	• 1x USB 3.2 Gen1 (Type A), 3x USB 2.0 (Type A)	
Serial Port	• 2x RS-232/422/485 with Auto Flow Control Support, DB9	
DIO	• 8x Isolated Digital I/O (4in/4out)	
Storage		
SSD/HDD	• 1x 2.5" HDD/SSD Drive	
SIM Card	• 1x Front Accessible SIM Socket	
CFast	• 1x Front Accessible CFast Socket	
Expansion		
Mini PCI Express	• 1x Full-size Mini-PCIe Socket for Wi-Fi/GSM/Expansion Module	
Universal Bracket		• 2x Universal I/O Bracket
Other Function		
Watchdog Timer	• Software Programmable Supports 256 Levels System Reset	
Internal Speaker	• AMP 2W + 2W	
OSD Function	• LCD On/Off, Brightness Up, Brightness Down	
Reset Button	• 1x Reset Button	
Power		
Power Button	• 1x ATX Power On/Off Switch	
Power Mode Switch	• 1x AT/ATX Mode Switch	
Power Input	• 1x 3-pin Terminal Block Connector with Power Input 9~48VDC	
Power Adapter (Optional)	• 1x Optional AC/DC 12V/5A, 60W	

Physical		
Dimension (W x D x H)	• 204.5 x 149 x 37.5 mm	• 204.5 x 150 x 60 mm
Weight Information	• 1.34kg	• 1.54kg
Mechanical Construction	• Extruded Aluminum with Heavy Duty Metal	
Mounting	• Wall / VESA / CDS Mounting	
Physical Design	• Fanless Design • Jumper-less Design	
Reliability & Protection		
Reverse Power Input	• Yes	
Over Voltage Protection	• Protection Range: 51~58V • Protection Type: shut down operating voltage, re-power on at the present level to recover	
Over Current Protection	• 20A	
Operating System		
Microsoft® Windows®	• Windows® 10, Windows® 8, Windows® 7 • Windows® Embedded 8 Standard, Windows® Embedded Standard 7	
Linux	• Supports by project	
Environment		
Operating Temperature	• Ambient with Air Flow: -20°C to 70°C (with Industrial Grade Peripherals)	
Storage Temperature	• -30°C to 85°C	
Relative humidity	• 10%~95% RH (Non-condensing)	
Shock	• Operating, 15 Grms, Half-sine 11 ms Duration (w/ SSD, according to IEC60068-2-27)	
Vibration	• Operating, 1 Grms, 5-500 Hz, 3 Axes (w/ SSD, according to IEC60068-2-64)	
EMC	• CE, UKCA, FCC, ICES-003 Class A	
EMI	• CISPR 32 Conducted & Radiated: Class A • EN/BS EN 55032 Conducted & Radiated: Class A • EN/BS EN IEC 61000-3-2 Harmonic current emissions: Class A • EN/BS EN61000-3-3 Voltage fluctuations & flicker • FCC 47 CFR Part 15B, ICES-003 Conducted & Radiated: Class A	
EMS	• EN/IEC 61000-4-2 ESD: Contact: 4 kV; Air: 8 kV • EN/IEC 61000-4-3 RS: 80 MHz to 1000 MHz: 3 V/m • EN/IEC 61000-4-4 EFT: AC Power: 1 kV; DC Power: 0.5 kV; Signal: 0.5 kV • EN/IEC 61000-4-5 Surges: AC Power: 2 kV; Signal: 1 kV • EN/IEC 61000-4-6 CS: 3V • EN/IEC 61000-4-8 PFMF: 50 Hz, 1A/m • EN/IEC 61000-4-11 Voltage Dips & Voltage Interruptions: 0.5 cycles at 50 Hz	

CS-108/P1001 External Layout

Front I/O

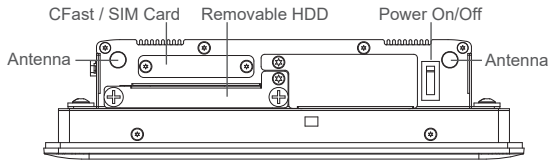

Rear I/O

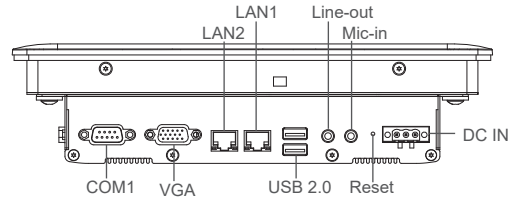

Left I/O

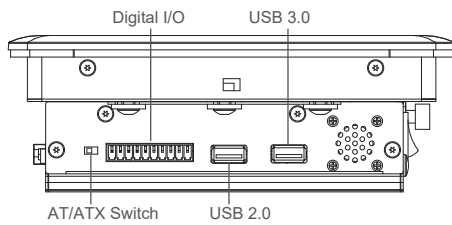

Right I/O

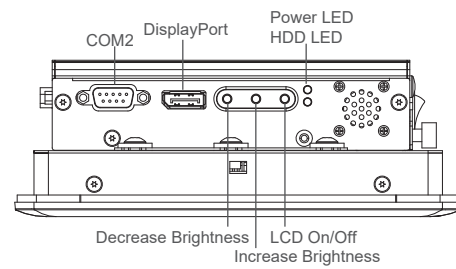

CS-108/P1001E External Layout

Front I/O

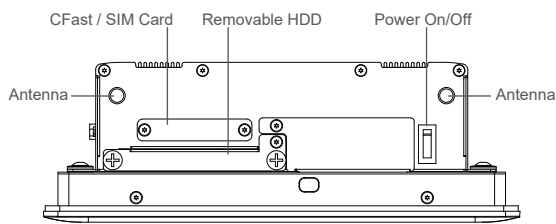

Rear I/O

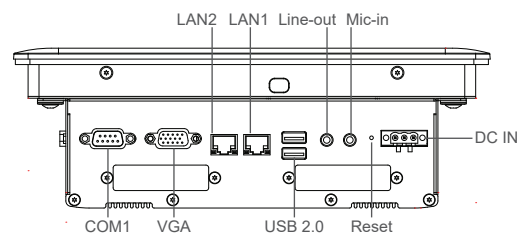

Left I/O

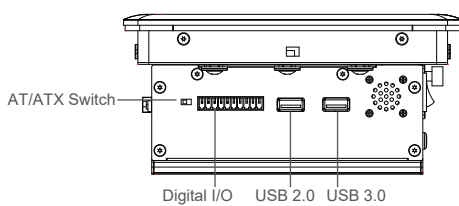

Right I/O

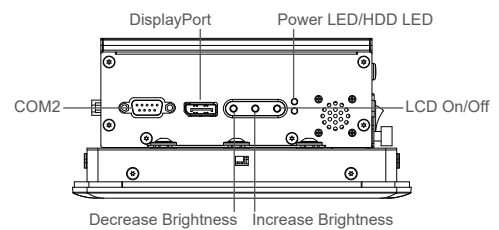

CS-108/P1001 Dimensions

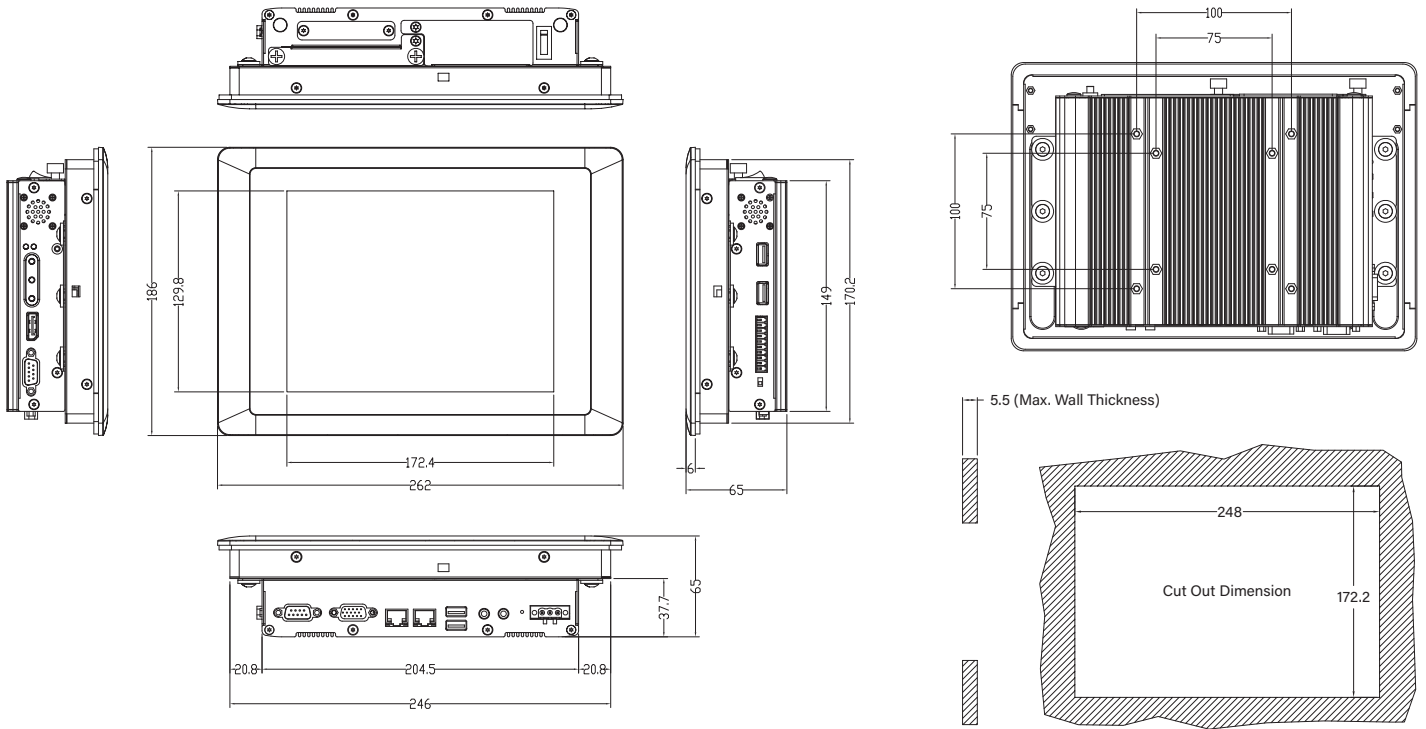

CS-108/P1001E Dimensions

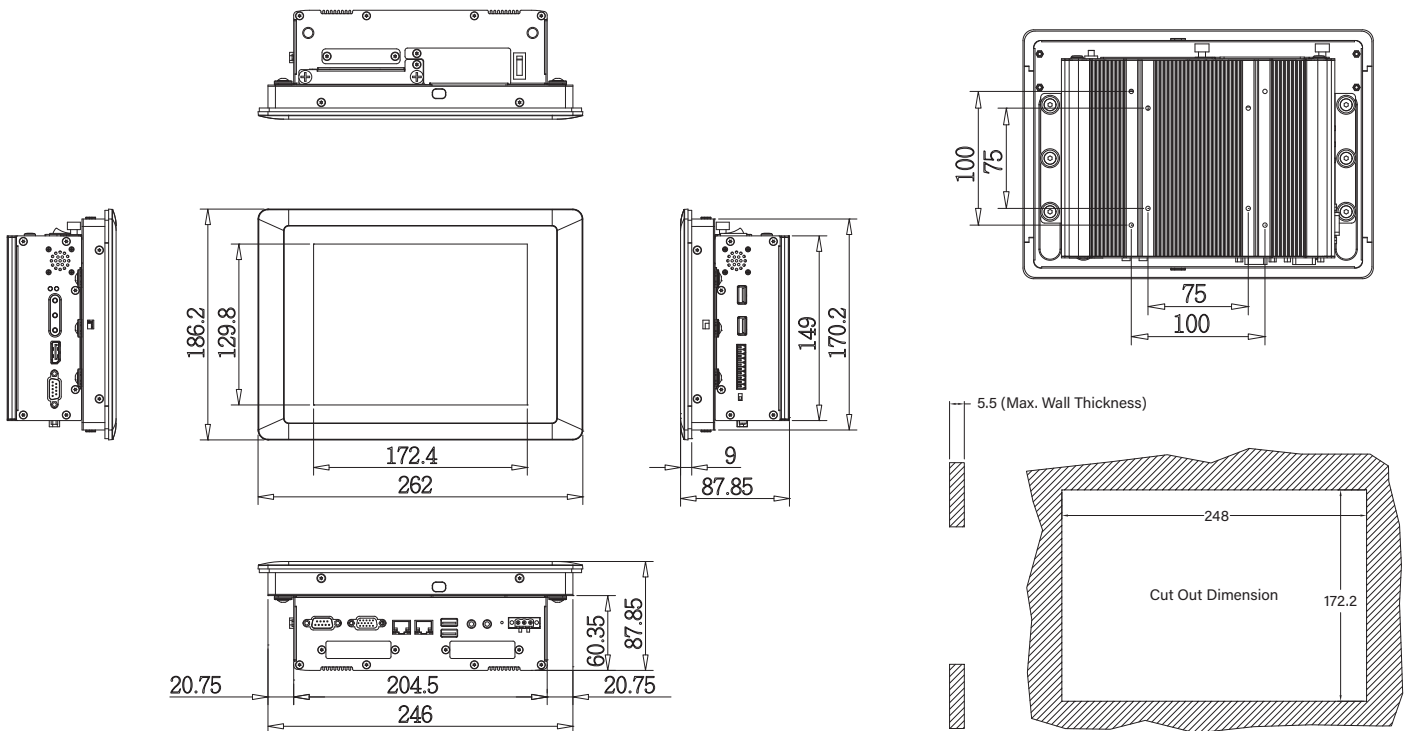

Ordering Information

Available Models

Model No.	Description
CS-108C-R10/P1001-R10	8.4" TFT-LCD 1600 nits Sunlight Readable Touch Panel PC with Intel® Atom™ E3845 Quad Core Processor and P-Cap. Touch
CS-108C-R10/P1001E-R10	8.4" TFT-LCD 1600 nits Sunlight Readable Touch Panel PC with Intel® Atom™ E3845 Quad Core Processor, P-Cap. Touch and 2x Universal I/O Bracket

Model Configuration

	CS-108C	P1001	P1001E
CS-108C/P1001	V	V	--
CS-108C/P1001E	V	--	V

V : Compatible

Package Checklist



• CS-108/P1001 Series Panel PC x 1	• Power Terminal Block Connector x 1
• Panel Mounting Kit x 1	• HDD Screw Pack x 1
• DIO Terminal Block Connector x 1	• Mini PCIe Screw Pack x 1

Optional Modules and Accessories

Model No.	Description
MEC-COM-M212-DB9	Mini-PCIe Module with 2x COM Ports, 1x Standard DB9 Cable (For P1001E only)
MEC-LAN-M102-30	Mini-PCIe Module with 2x LAN Ports, 2x 30cm cable (For P1001E only)
MEC-USB-M102-30	Mini-PCIe Module with 2x USB 3.2 Gen1 Ports, 1x 30cm cable (For P1001E only)
UB0303	2x Universal Bracket each with 1x DB9 Cutout (For P1001E only)
UB0311	1x Universal Bracket with 2x RJ45 Cutout (For P1001E only)
UB0314	1x Universal Bracket with 2x USB Cutout (For P1001E only)
URM01	Universal 19" Rack Mount Kit for Industrial Panel PC & Industrial Monitor
GST60A12-CIN1	Adapter AC/DC 12V 5A 60W, GST60A12-CIN1, wide temp (-30°C ~ +70°C)
SL2-SL3	US 2 heads power cord, US B type to IEC C13, SVT 18AWG/3C Black 1.8M SL-2+SL-3
SL6-SL3	EU 2 heads power cord, EU G type to IEC C13, H05VV-F 0.75mm2/3G Black 1.8M SL-6+SL-3
QP026-SL3	UK 2 heads power cord, UK I type to IEC C13, H05VV-F 0.75mm2/3G Black 1.8M QP026+SL-3

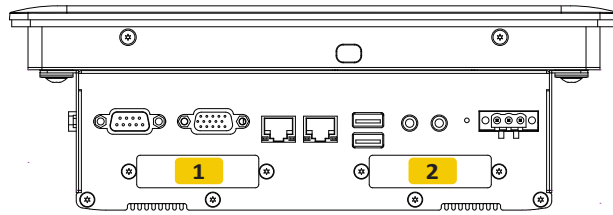
Optional Module Configuration (For P1001E only)

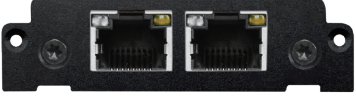

Model No.	Description	1	2
 <p>MEC-COM-M212-DB9/UB0303</p>	Mini-PCIe Module with 2x COM Ports, 1x Standard DB9 Cable, 2x Universal Bracket each with 1x DB9 Cutout	V	V
 <p>MEC-LAN-M102-30/UB0311</p>	Mini-PCIe Module with 2x LAN Ports, 2x 30cm cable, w/ 1x Universal Bracket with 2x RJ45 Cutout	V	V
 <p>MEC-USB-M102-30/UB0314</p>	Mini-PCIe Module with 2x USB 3.2 Gen1 Ports, 1x 30cm cable, 1x Universal Bracket with 2x USB Cutout	V	V

V : Compatible