

# CS-112H/P2302 Series

12.1" TFT-LCD 1500nits Sunlight Readable Display Modular & Expandable Panel PC with Intel Meteor Lake-PS Core Series (LGA Socket) Processor and Projected Capacitive Touch



## HIGH-PERFORMANCE SUNLIGHT READABLE PANEL PC

| CS-100/P2000 Series |

### Overview

[CONTACT](#)

The CS-100/P2302 series are high-performance sunlight-readable industrial panel PCs with ultra-high brightness displays of up to 1,800 nits. The series supports Intel® Core Ultra processors (Meteor Lake-PS) and provides nearly 10 options for screen size, ratio, and brightness. Rich I/O, flexible expansion, rugged design, and easy on-site maintenance make the CS-100/P2302 series the best choice for outdoor Kiosk or HMI applications.

### Key Features

- 12.1" XGA TFT 4:3 LCD with Projected Capacitive Touch
- Intel® Meteor Lake-PS Core™ Ultra 7/5/3 Processor
- 2 x DDR5 SO-DIMM Socket, Supports up to 5600MHz 96GB Memory
- Ultra High Brightness up to 1,500 nits
- Quad Independent Display (CDS / HDMI / DP / VGA)
- 1x M.2 Key E Type 2230 Socket for Wireless / Bluetooth Module Expansion
- 1 x M.2 Key B Type 3052/3042 Socket for 5G/GNSS/Storage/Add-on Card Expansion
- 1x M.2 Key B Type 3042 Socket for Storage/Add-on Card Expansion
- Designed with Aluminum Die-cast Front Bezel
- Front Panel IP65 Compliant

**Improved Performance x  
Power-Saving x AI Boost**

The CS-100/P2302 series supports Intel® 4 Core Ultra 7/5/3 U Series (Meteor Lake-PS) processors with up to 12 cores and 15W low power consumption, providing 1.8 times the performance of the previous model. The new built-in Intel NPU delivers faster and more efficient AI acceleration capabilities for high-volume image processing and AI recognition.



**1.8x Faster Processing Power**

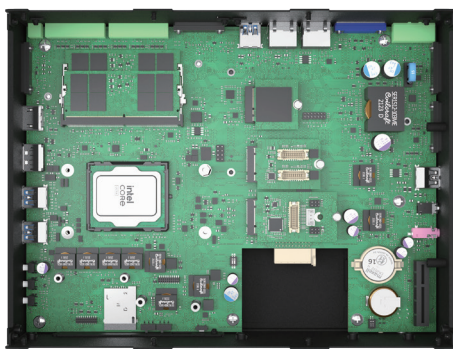
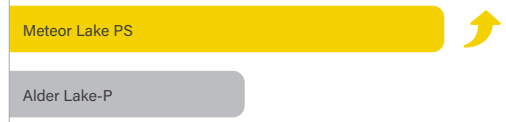

**High Flexibility, Unlimited Applications**

The CS-100/P2302 series offers outstanding flexibility, supporting Core Ultra U-series LGA CPUs for customizable performance. It features M.2 Key B/E slots for 5G, Wi-Fi, Bluetooth, NVMe SSDs, and I/O expansion. The CS-100/P2302E further supports PCI/PCIe slots for expansion cards (up to 75W, 111 x 169 mm), enabling diverse applications.

**CDS Technology**

Our exclusive CDS (Convertible Display System) technology enables easy maintenance in the field and simplifies future upgrades. Replacing the display or improving system performance only requires replacing a single component, significantly saving upgrade costs.



## Complete Range of Sizes

The CS-100/P2302 series has various display options to suit various applications. Display options include screen sizes from 12" to 24", Full HD resolution, up to 1,800 nits high brightness, and projective capacitive touchscreen.

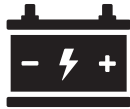

**9 - 48VDC**



**IP65**

## Wide Temperature, Safe, Reliable

The CS-100/P2302 has safety and protection mechanisms to overcome harsh outdoor environments and unpredictable climates. Industrial-grade protections include wide temperature, wide voltage, and IP65 waterproof and dustproof front panel.

**CS-112H Specifications**

Model Name	CS-112HC
<b>Display</b>	
LCD Size	• 12.1" (4:3)
Max. Resolution	• 1024 x 768 (XGA)
Brightness (cd/m2)	• 1500
Contrast Ratio	• 700 : 1
LCD Color	• 16.7M
Pixel Pitch (mm)	• 0.24 (H) x 0.24 (V)
Viewing Angle (H-V)	• 160 / 140
Backlight LED Life Time	• 50,000 hrs (LED Backlight)
<b>Touch Screen</b>	
Touch Type	• Projected Capacitive
Wet Touch Tracking	v
<b>Physical</b>	
Dimension ( W x D x H )	• 345 x 265.3 x 57 mm
Weight Information	• 3.16 kg
Mechanical Construction	• Flat Rugged Aluminum Die-casting Bezel
<b>Power</b>	
Power Consumption	• 16.22W (Typ.)
<b>Environment</b>	
Front Panel Protection	• IP 65 Compliant
Operating Temperature	• -20°C to 70°C (-4°F to 158°F) (With Industrial Grade Peripherals; Ambient with air flow)
Storage Temperature	• -30°C to 80°C (-22°F to 176°F)
Relative Humidity	• 90% RH @ 40°C (Non-condensing)
EMC	• CE, UKCA, FCC, ICES-003 Class A
EMI	<ul style="list-style-type: none"> <li>• CISPR 32 Conducted &amp; Radiated: Class A</li> <li>• EN/BS EN 55032 Conducted &amp; Radiated: Class A</li> <li>• EN/BS EN IEC 61000-3-2 Harmonic current emissions: Class A</li> <li>• EN/BS EN61000-3-3 Voltage fluctuations &amp; flicker</li> <li>• FCC 47 CFR Part 15B, ICES-003 Conducted &amp; Radiated: Class A</li> </ul>
EMS	<ul style="list-style-type: none"> <li>• EN/IEC 61000-4-2 ESD: Contact: 4 kV; Air: 8 kV</li> <li>• EN/IEC 61000-4-3 RS: 80 MHz to 1000 MHz: 3 V/m</li> <li>• EN/IEC 61000-4-4 EFT: AC Power: 1 kV; DC Power: 0.5 kV; Signal: 0.5 kV</li> <li>• EN/IEC 61000-4-5 Surges: AC Power: 2 kV; Signal: 1 kV</li> <li>• EN/IEC 61000-4-6 CS: 3V</li> <li>• EN/IEC 61000-4-8 PFMF: 50 Hz, 1A/m</li> <li>• EN/IEC 61000-4-11 Voltage Dips &amp; Voltage Interruptions: 0.5 cycles at 50 Hz</li> </ul>
Safety	• UL, cUL, CB, IEC, EN 62368-1

**P2302 Specifications**

Model Name	P2302	P2302E
<b>System</b>		
Processor	<ul style="list-style-type: none"> <li>Intel® Meteor Lake-PS Core™ Ultra 7/5/3 Processor                             <ul style="list-style-type: none"> <li>- Intel® Core™ Ultra 7 Processor 165UL 12 Cores Up to 4.9 GHz, TDP 15W</li> <li>- Intel® Core™ Ultra 7 Processor 155UL 12 Cores Up to 4.8 GHz, TDP 15W</li> <li>- Intel® Core™ Ultra 5 Processor 135UL 12 Cores Up to 4.4 GHz, TDP 15W</li> <li>- Intel® Core™ Ultra 5 Processor 125UL 12 Cores Up to 4.3 GHz, TDP 15W</li> <li>- Intel® Core™ Ultra 3 Processor 105UL 8 Cores Up to 4.2 GHz, TDP 15W</li> </ul> </li> </ul>	
Memory	<ul style="list-style-type: none"> <li>2x DDR5 5600 MHz SO-DIMM Socket, Supports Un-buffered and non-ECC Type, Up to 96 GB</li> </ul>	
BIOS	<ul style="list-style-type: none"> <li>AMI BIOS</li> </ul>	
<b>Graphics</b>		
Graphics Engine	<ul style="list-style-type: none"> <li>Intel® Graphics</li> </ul>	
Maximum Display Output	<ul style="list-style-type: none"> <li>Supports Quad Independent Display</li> </ul>	
CDS	<ul style="list-style-type: none"> <li>1x CDS Connector (1920 x 1080 @60Hz)</li> </ul>	
DP	<ul style="list-style-type: none"> <li>1x DisplayPort Connector (4096 x 2304 @60Hz)</li> <li>* Verified maximum resolution: 3840 x 2160 @ 60Hz</li> </ul>	
HDMI	<ul style="list-style-type: none"> <li>1x HDMI Connector (3840 x 2160 @30Hz)</li> </ul>	
VGA	<ul style="list-style-type: none"> <li>1x VGA Connector (1920 x 1080 @60Hz)</li> </ul>	
<b>Audio</b>		
Audio Codec	<ul style="list-style-type: none"> <li>Realtek® ALC888, High Definition Audio</li> </ul>	
Line-out	<ul style="list-style-type: none"> <li>1x Line-out, Phone Jack 3.5mm</li> </ul>	
Mic-in	<ul style="list-style-type: none"> <li>1x Mic-in, Phone Jack 3.5mm</li> </ul>	
<b>I/O</b>		
LAN	<ul style="list-style-type: none"> <li>2x 2.5GbE LAN, RJ45                             <ul style="list-style-type: none"> <li>- GbE1: Intel® I225</li> <li>- GbE2: Intel® I225</li> </ul> </li> </ul>	
COM	<ul style="list-style-type: none"> <li>4x RS-232/422/485 with Auto Flow Control (Supports 5V/12V), DB9</li> </ul>	
USB	<ul style="list-style-type: none"> <li>2 x USB 3.2 Gen2x1 (10Gbps), Type A</li> <li>1 x USB 3.2 Gen1x1 (5Gbps), Type A</li> <li>1 x USB 2.0 (480Mbps), Type A</li> </ul>	
DIO	<ul style="list-style-type: none"> <li>16x Isolated Digital I/O (8in/8out), 20-Pin Terminal Block</li> </ul>	
<b>Storage / Expansion</b>		
2.5" SSD/HDD	<ul style="list-style-type: none"> <li>2x 2.5" SATA HDD/SSD Bay (SATA 3.0)</li> </ul>	
M.2 Key E Socket	<ul style="list-style-type: none"> <li>1x M.2 Key E Type 2230 Socket (PCIe Gen 3x1 / USB2.0), Support Wireless/Bluetooth Module Expansion</li> </ul>	
M.2 Key B Socket	<ul style="list-style-type: none"> <li>1x M.2 Key B Type 3042/3052 Socket (PCIe Gen 4x2 / USB3.2 Gen2 x1 / USB2.0), Support 5G/GNSS/Storage/Add-on Card Expansion</li> <li>1x M.2 Key B Type 3042 (PCIe Gen 3x2 / USB2.0), Support Storage/Add-on Card Expansion</li> </ul>	
PCI Express		<ul style="list-style-type: none"> <li>1x PCI or 1x PCIe Gen3 x4 Expansion slot (with Optional Riser Card)</li> <li>Supports maximum dimensions of add-on card (H x L) : 111 x 169mm</li> </ul>
SIM Socket	<ul style="list-style-type: none"> <li>1 x Front Accessible SIM Socket</li> </ul>	
CFM (Control Function Module) Interface	<ul style="list-style-type: none"> <li>1x CFM Interface for optional IGN Module Expansion</li> <li>1x CFM Interface for optional PoE Module Expansion</li> </ul>	

<b>Other Function</b>	
RAID	• RAID 0/1
Clear CMOS Switch	• 1x Clear CMOS Switch
Reset Button	• 1x Reset Button
Watchdog Timer	• Software Programmable Supports 256 Levels System Reset
OSD Button	• LCD On/Off, Brightness Up, Brightness Down
Internal Speaker	• AMP 2W + 2W
Status LED Indicator	• Power LED, Storage LED
Antenna Holes	• 6x Antenna Holes
<b>Power</b>	
Power Button	• 1x ATX Power On/Off Button
Power Mode Switch	• 1x AT/ATX Mode Switch
Power Input	• 9 - 48VDC, 3-pin Terminal Block
Remote Power On/Off	• 1x Remote Power On/Off, 2-pin Terminal Block
Max. Power Consumption	• Intel Core™ Ultra 7 Processor 165UL: 79.7W - Test conducted with CPU, 1x RAM, and 1x storage - 100% load during burn-in testing
Inrush Current (Peak)	• Intel Core™ Ultra 7 Processor 165UL: 5.010 A@24V
<b>Operating System</b>	
Windows	• Windows®11, Windows®10
Linux	• Ubuntu Desktop 24.04 LTS
<b>Physical</b>	
Dimension( W x D x H )	• 254.5 x 190 x 49.5 mm      • 254.5 x 190 x 69 mm
Weight Information	• 2.16 kg      • 2.26 kg
Mechanical Construction	• Extruded Aluminum with Heavy Duty Metal
Mounting	• Wall / VESA / CDS / DIN Rail
Physical Design	• Fanless Design • Jumper-less Design
<b>Reliability &amp; Protection</b>	
Reverse Power Input Protection	• Yes
Over Voltage Protection	• Protection Range: 51~58V • Protection Type: shut down operating voltage, re-power on at the preset level to recover
Over Current Protection	• 15A
CMOS Battery Backup	• SuperCap Integrated for CMOS Battery Maintenance-free Operation
MTBF	• 206,043 Hours - Database: Telcordia SR-332 Issue3, Method 1, Case 3
<b>Environment</b>	
Operating Temperature	• -40°C to 65°C (-40°F to 149°F) * PassMark BurnIn Test: 100% CPU, 2D/3D Graphics (without thermal throttling) * With extended temperature peripherals; Ambient with air flow * According to IEC60068-2-1, IEC60068-2-2, IEC60068-2-14
Storage Temperature	• -40°C to 85°C (-40°F to 185°F)

Relative Humidity	<ul style="list-style-type: none"> <li>• 95%RH @ 65°C (non-Condensing)</li> </ul>
Shock	<ul style="list-style-type: none"> <li>• Operating, 50 Grms (w/SSD, according to IEC60068-2-27)</li> <li>• MIL-STD-810H</li> </ul>
Vibration	<ul style="list-style-type: none"> <li>• Operating, 1 Grms, 10-500 Hz, 3 Axes (w/SSD, according to IEC60068-2-6)</li> <li>• MIL-STD-810H</li> </ul>
EMC	<ul style="list-style-type: none"> <li>• CE, UKCA, FCC, ICES-003 Class A</li> </ul>
EMI	<ul style="list-style-type: none"> <li>• CISPR 32 Conducted &amp; Radiated: Class A</li> <li>• EN/BS EN 55032 Conducted &amp; Radiated: Class A</li> <li>• EN/BS EN IEC 61000-3-2 Harmonic current emissions: Class A</li> <li>• EN/BS EN61000-3-3 Voltage fluctuations &amp; flicker</li> <li>• FCC 47 CFR Part 15B, ICES-003 Conducted &amp; Radiated: Class A</li> </ul>
EMS	<ul style="list-style-type: none"> <li>• EN/IEC 61000-4-2 ESD: Contact: 4 kV; Air: 8 kV</li> <li>• EN/IEC 61000-4-3 RS: 80 MHz to 1000 MHz: 10 V/m</li> <li>• EN/IEC 61000-4-4 EFT: AC Power: 2 kV; DC Power: 1 kV; Signal: 1 kV</li> <li>• EN/IEC 61000-4-5 Surges: AC Power: 2 kV; Signal: 1 kV</li> <li>• EN/IEC 61000-4-6 CS: 10V</li> <li>• EN/IEC 61000-4-8 PFMF: 50 Hz, 30A/m</li> <li>• EN/IEC 61000-4-11 Voltage Dips &amp; Voltage Interruptions: 1 cycles at 60 Hz</li> </ul>
Industrial Environment	<ul style="list-style-type: none"> <li>• EMC               <ul style="list-style-type: none"> <li>- EN/BS/IEC 61000-6-4: 2019 Class A</li> <li>- EN/BS/IEC 61000-6-2: 2019</li> </ul> </li> </ul>
Safety	<ul style="list-style-type: none"> <li>• UL, cUL, CB, IEC, EN 62368-1</li> </ul>

**CS-112H/P2302 External Layout**

Front I/O

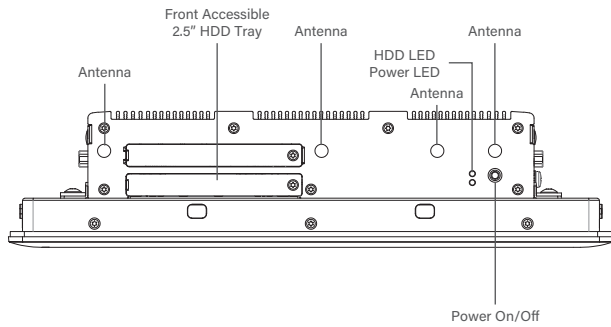

Rear I/O

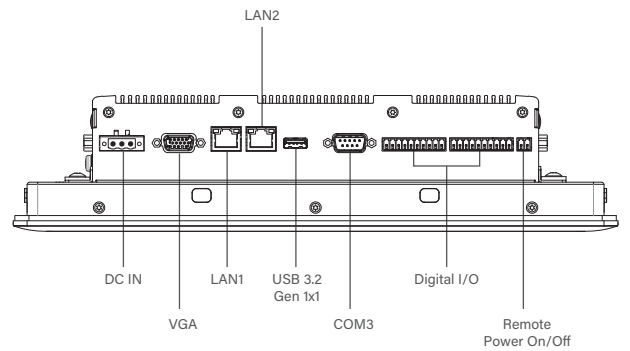

Left I/O

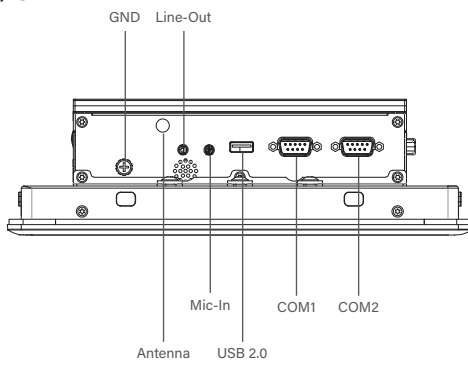

Right I/O

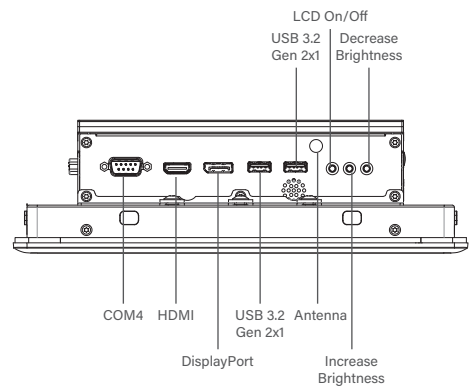

**CS-112H/P2302E External Layout**

Front I/O

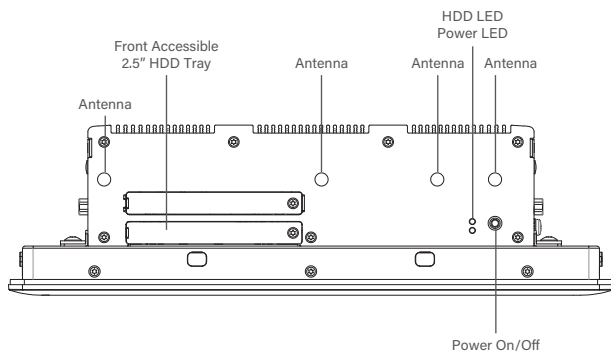

Rear I/O

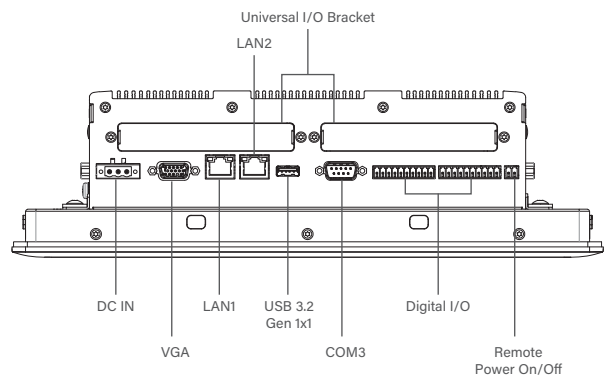

Left I/O

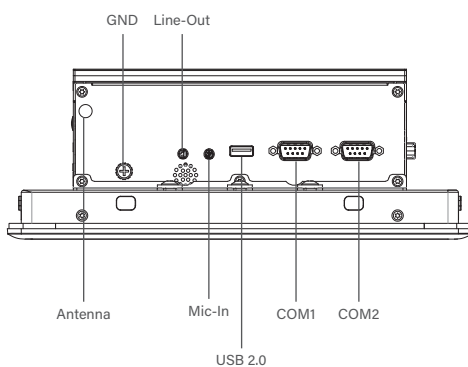

Right I/O

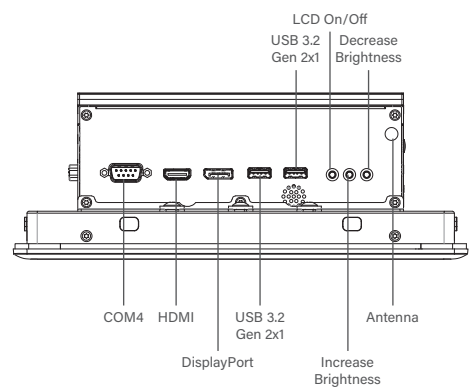

**CS-112H/P2302 Dimensions**

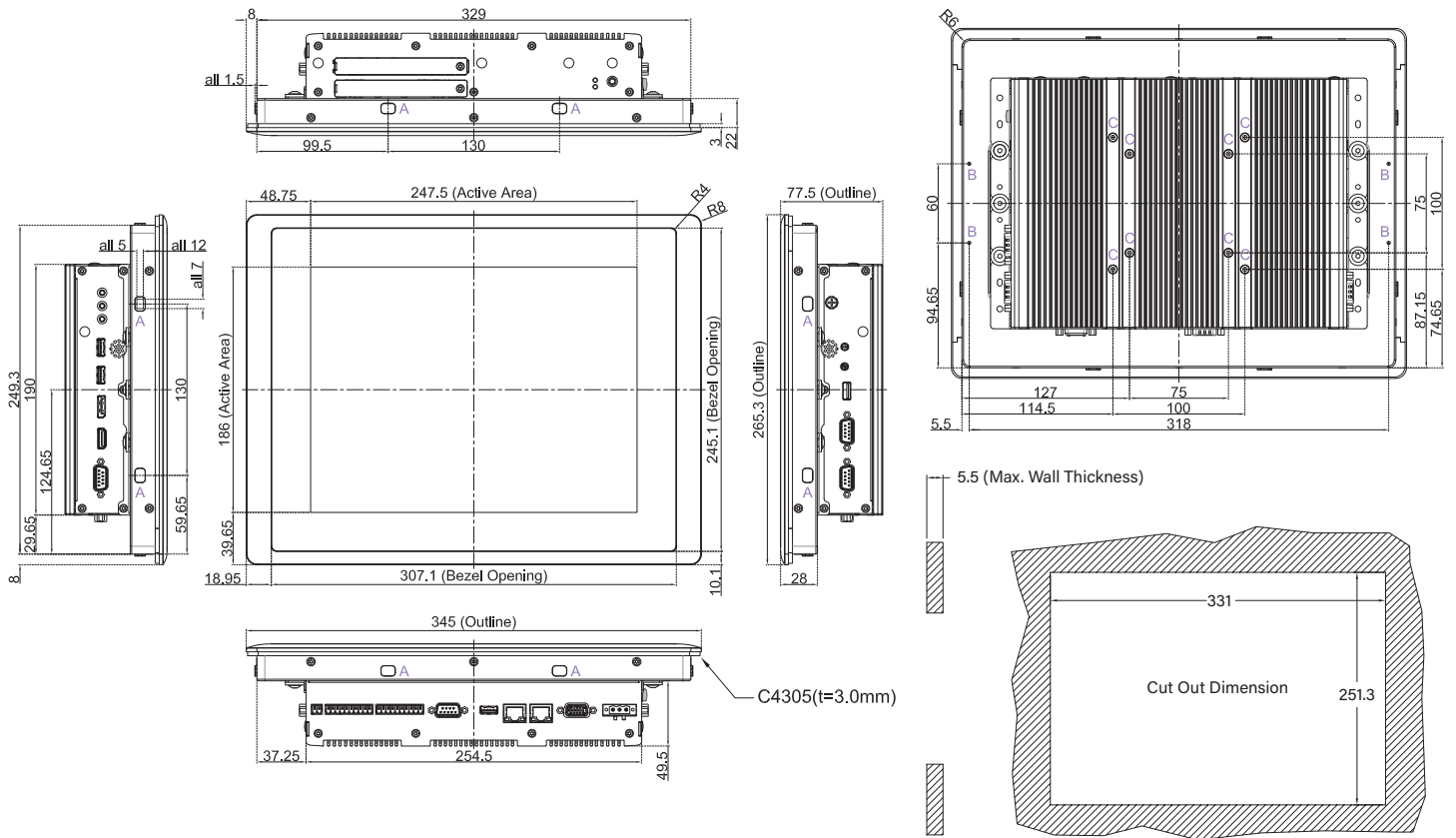

**CS-112H/P2302E Dimensions**

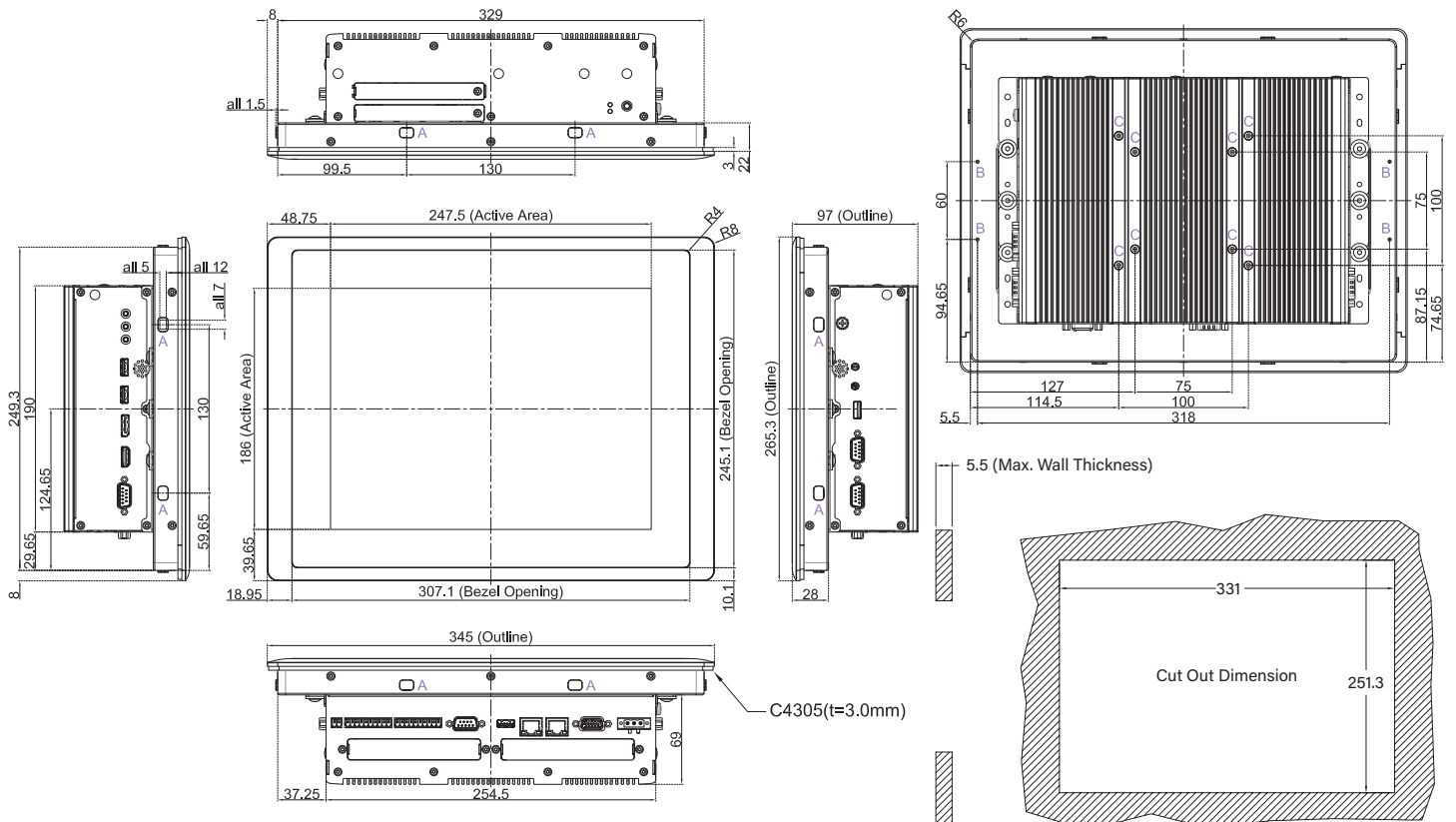

## Ordering Information

### Available Models

Model No.	Description
CS-112HC-R11/P2302-R10	12.1" TFT-LCD 1500nits Sunlight Readable Display Modular Panel PC with Intel Meteor Lake-PS Core Series (LGA Socket) Processor and Projected Capacitive Touch
CS-112HC-R11/P2302E-R10	12.1" TFT-LCD 1500nits Sunlight Readable Display Modular and Expandable Panel PC with Intel Meteor Lake-PS Core Series (LGA Socket) Processor and Projected Capacitive Touch

### Model Configuration

	CS-112HC	P2302	P2302E
CS-112HC/P2302	V	V	--
CS-112HC/P2302E	V	--	V

V : Compatible

### Package Checklist

• CS-112H/P2302 Series Panel PC x1	• PCI / PCIe Card Installation Kit x1 (For P2302E Only)
• Power Terminal Block x1	• Screw Pack x4
• Remote Power On/Off Terminal Block Connector x1	• Heatsink Kit x1
• DIO Terminal Block Connector x2	• M.2 Key B Type 3052 to 3042 Adapter Bracket x1
• Panel Mounting Kit x8	

**Optional Modules and Accessories**

Model No.	Description
CFM-IGN101	CFM Module with Power Ignition Sensing Control Function, 12V/24V Voltage Detection Selectable
CFM-PoE08-R10	CFM Module with PoE Control Function, Individual Port 25.5W (For P2302 Only)
CFM-PoE09-R10	CFM Module with PoE Control Function, Individual Port 25.5W (For P2302E Only)
MEC-LAN-2002i	M.2 2242/2260/2280 2-port 10/100/1000 Isolated Ethernet Board(-40°C~+85°C), 2x RJ45 Connector
MEC-LAN-2002i-S	M.2 2242/2260/2280 2-port 10/100/1000 Isolated Ethernet Board(-0°C~+70°C), 2x RJ45 Connector
MEC-USB-2002-SP	M.2 2242/2260/2280 2 port USB 3.2 board(-0°C~+70°C), w/ IDE 20P 90° Cable, 2x USB Type A Connector *Only one MEC-USB-2002-SP can be installed on the P2302E
MEC-USB-2002C	M.2 2242/2260/2280 2-port USB 3.2 Board(-0°C~+70°C), 2x USB Type C Connector
MEC-COM-2012	M.2 2242/2260/2280 (B+M Key) 2-port RS-232 Serial Board (-40°C~+85°C), 2x DB9 Connector
MEC-COM-2032i	M.2 2242/2260/2280 (B+M key) 2-port RS-232/422/485 isolated serial board (-40°C~+85°C), 2x DB9 Connector
RC-E4-02	Riser Card with 1x PCIe x4 Slot (For P2302E Only)
RC-PI-02	Riser Card with 1x PCI Slot (For P2302E Only)
UB1203	Universal Bracket with 2x DB9 Cutout for MEC-COM Expansion
UB1211	Universal Bracket with 2x RJ45 Cutout for MEC-LAN Expansion
UB1233-R10	Universal Bracket with 2x USB Type C Cutout for MEC-USB Expansion
UB1234-R10	Universal Bracket with 2x USB Type A Cutout for MEC-USB (M.2 interface) Expansion
DIN01	DIN-RAIL Mount Kit, KMRH-K175
GST120A24-CIN	Adapter AC/DC 24V 5A 120W with 3pin Terminal Block Plug 5.0mm Pitch, with TUBES, Level VI
GST220A24-CIN	Adapter AC/DC 24V 9.2A 220W with 3pin Terminal Block Plug 5.0mm Pitch, with TUBES, level VI
GST360A24-CIN	Adapter AC/DC 24V 15A 360W with 3pin Terminal Block Plug 5.0mm Pitch, with TUBES, Level VI

**Optional Module Configuration (For P2302E only)**

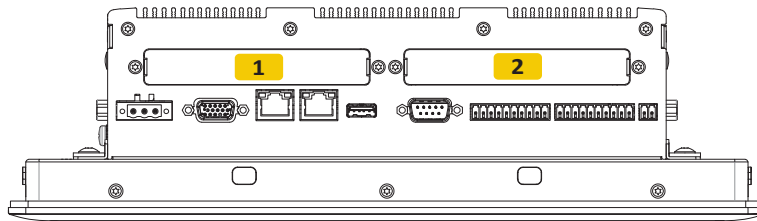

Model No.	Description	1	2
 <p>MEC-LAN-2002i/UB1211</p>	M.2 2242/2260/2280 2-port 10/100/1000 Isolated Ethernet Board (-40°C~+85°C), 2x RJ45 Connector / Universal Bracket with 2x RJ45 Cutout for MEC-LAN Expansion	V	V
 <p>MEC-LAN-2002i-S/UB1211</p>	M.2 2242/2260/2280 2-port 10/100/1000 Isolated Ethernet Board (-0°C~+70°C), 2x RJ45 Connector / Universal Bracket with 2x RJ45 Cutout for MEC-LAN Expansion	V	V
 <p>MEC-USB-2002-SP/UB1234-R10</p>	M.2 2242/2260/2280 2 port USB 3.2 board(-0°C~+70°C), w/ IDE 20P 90° Cable, 2x USB Type A Connector / Universal Bracket with 2x USB Type A Cutout for MEC-USB (M.2 interface) Expansion *Only one MEC-USB-2002-SP can be installed on the P2302E	V	V
 <p>MEC-USB-2002C/UB1233-R10</p>	M.2 2242/2260/2280 2-port USB 3.2 Board(-0°C~+70°C), 2x USB Type C Connector / Universal Bracket with 2x USB Type C Cutout for MEC-USB Expansion	V	V
 <p>MEC-COM-2012/UB1203</p>	M.2 2242/2260/2280 (B+M Key) 2-port RS-232 Serial Board (-40°C~+85°C), 2x DB9 Connector / Universal Bracket with 2x DB9 Cutout for MEC-COM & MEC-CAN Expansion	V	V
 <p>MEC-COM-2032i/UB1203</p>	M.2 2242/2260/2280 (B+M key) 2-port RS-232/422/485 isolated serial board (-40°C~+85°C), 2x DB9 Connector / Universal Bracket with 2x DB9 Cutout for MEC-COM & MEC-CAN Expansion	V	V
 <p>RC-E4-02</p>	Riser Card with 1x PCIe x4 Slot	V	-
 <p>RC-PI-02</p>	Riser Card with 1x PCI Slot	V	-

V : Compatible